

Art Sphere, Inc.
Coloring the Garden of Your Mind

A coloring book for all ages

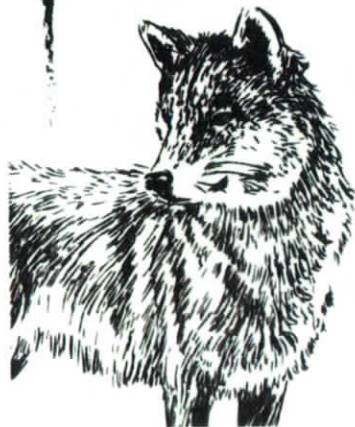

www.artsphere.org



#artsphereinc



Art Sphere Inc.: Coloring the Garden of Your Mind

Follow your creativity and make art that goes beyond coloring to utilize cutting and folding to create 2-D and 3-D art, pop up cards, toys, puppets, games and more!

Preface

We are pleased to present Art Sphere Inc.'s (ASI) s first coloring book where we explore the themes of art, nature, and wellness! Use the pages from this book to grow your own garden of creativity by transforming the pages of this book into art.

Through these creative exercises, you can explore the mind, body and spirit connection.

Art can be a tool to live intentionally, share mindfulness and even promote living well through coloring, cutting and creating.

How this Book Came About

ASI has always been concerned about the lack of access to and cutbacks in funding for the cultural arts in inner cities. In response, in 2014, through a grant from the John S. and James L. Knight Foundation, we developed a book of free art lesson plans, "Creating Legacies through Art," for teachers, parents and young artists everywhere to stimulate and inspire creative thinking (<http://artsphere.org/creating-legacies-through-art/>). This coloring book builds on our first book by taking our art projects to the next level. It is a collaborative work of local artists, designers, teachers and drawing enthusiasts. The proceeds of the book sales will be used to support ASI's free art education classes for inner-city youth.

How to Use this Book

The projects in this book, which have been tested in Art Sphere workshops and in schools, at public events and with diverse audiences, are designed to be easy enough for a parent or a teacher with no art training to teach to others. Printed lesson plans and other creative ideas are supplemented by a database on ASI's website (www.artsphere.org) that can be downloaded by teachers and families. All the projects can be completed in an hour or less and are intended for children from preschool to 6th grade - though we have found artists of all ages also find these activities to be relaxing and rewarding.

What we Hope you will Gain from Using this Book

Not everyone learns the same way. Some people are more visual, some more musical, some more mathematical. Our coloring sheets give viewers an opportunity to make art in more than one way and also to incorporate ideas such as compassion, respect for nature, healthy eating, cooperation, and other ideas for living in a way that contributes to a civil society. By pointing out the different ways that a project can be approached, parents and teachers can guide their children to their individual paths to artistic success and ways to express their unique creative voices.

May you harvest all the fruits of your creative efforts and gain the good fortune of living a more inspired life.



www.artsphere.org

#artsphereinc

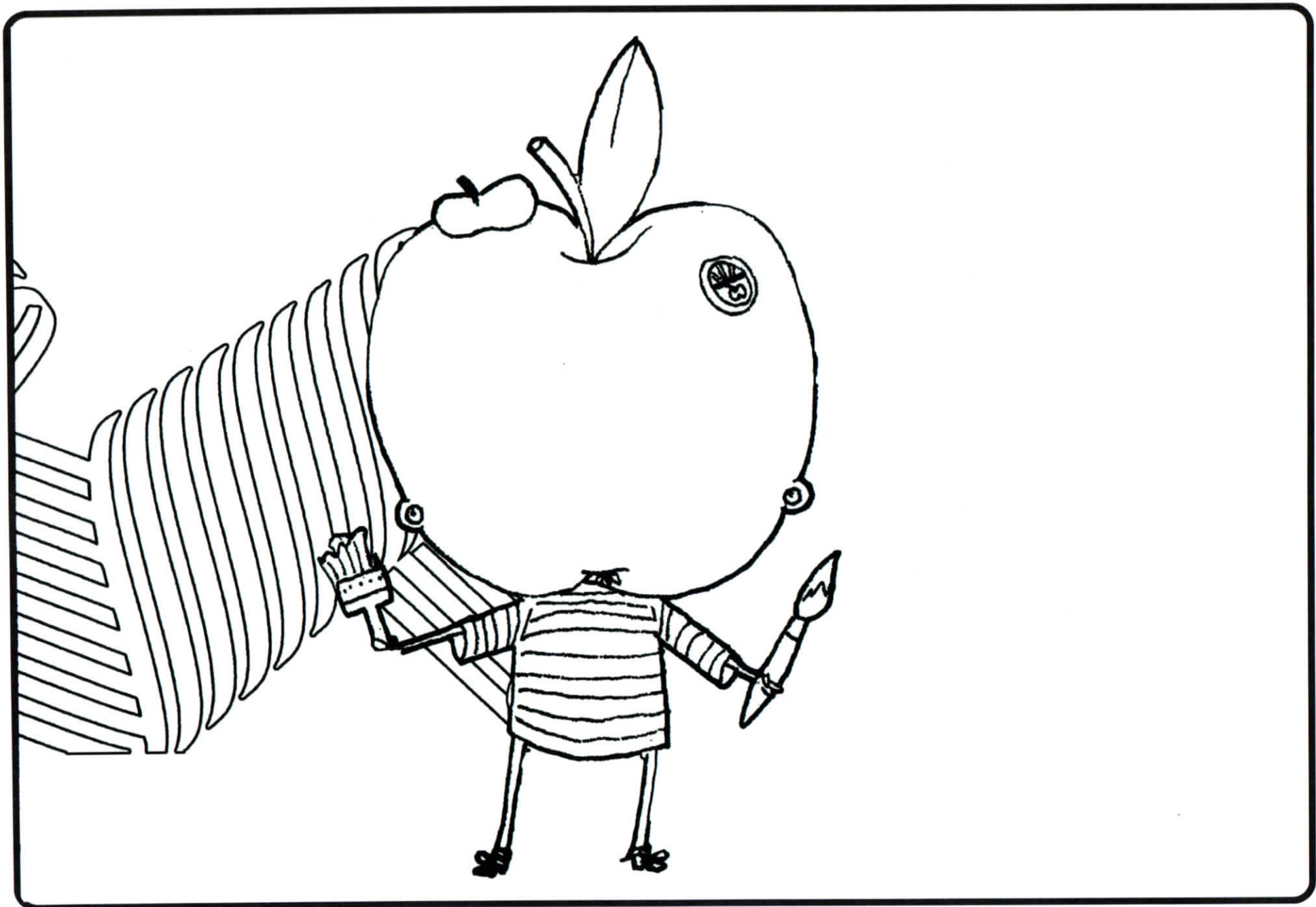



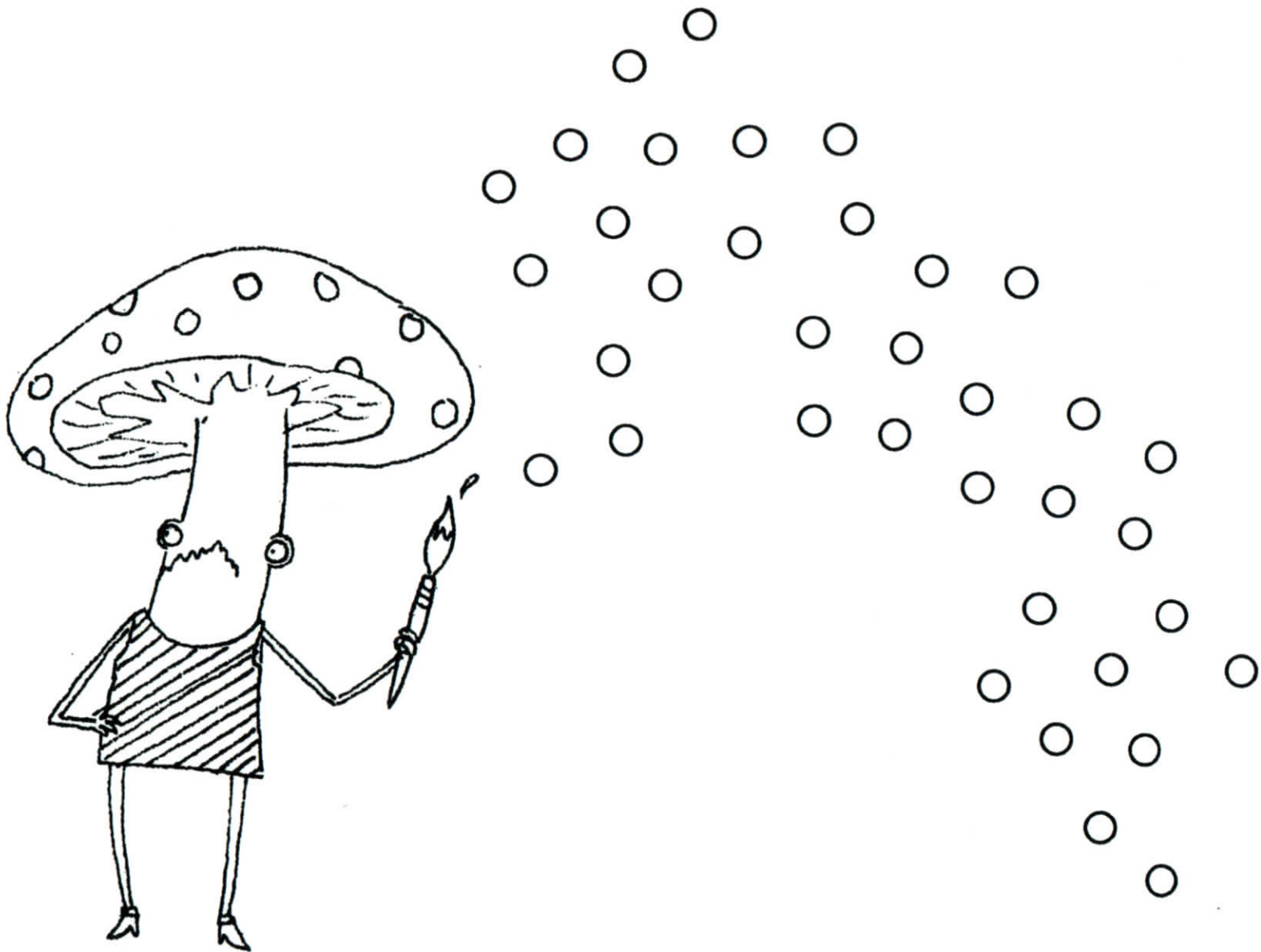





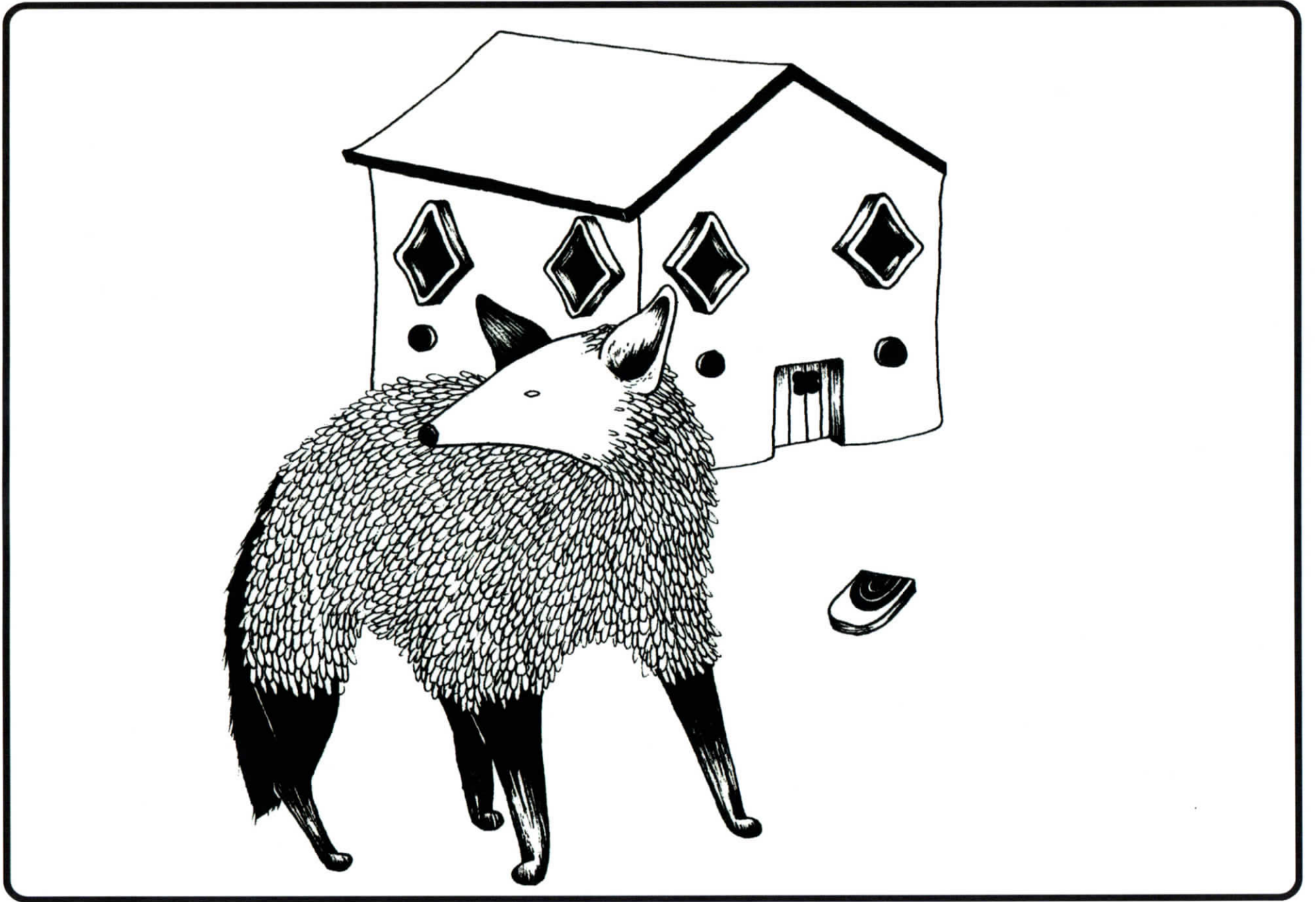

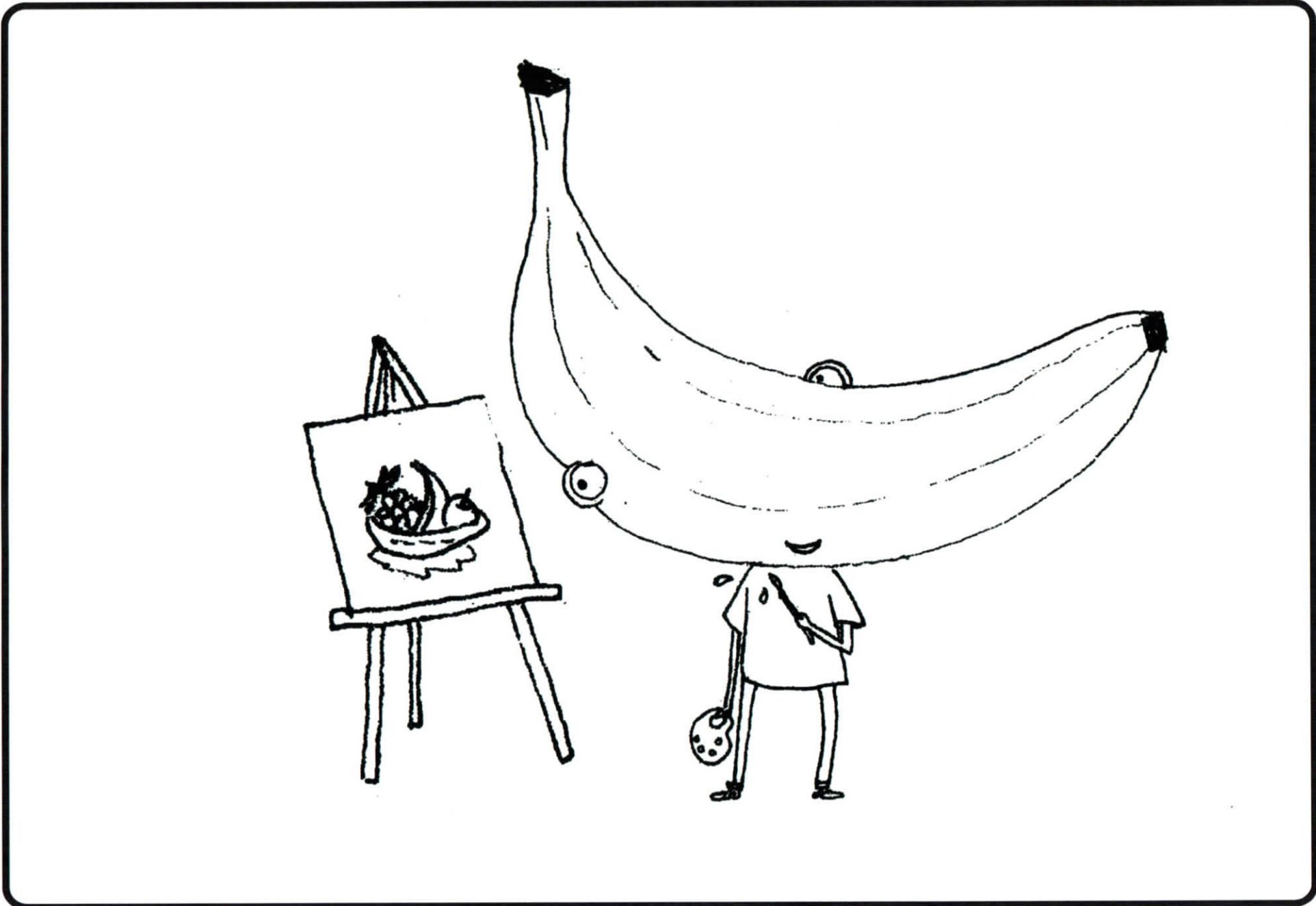

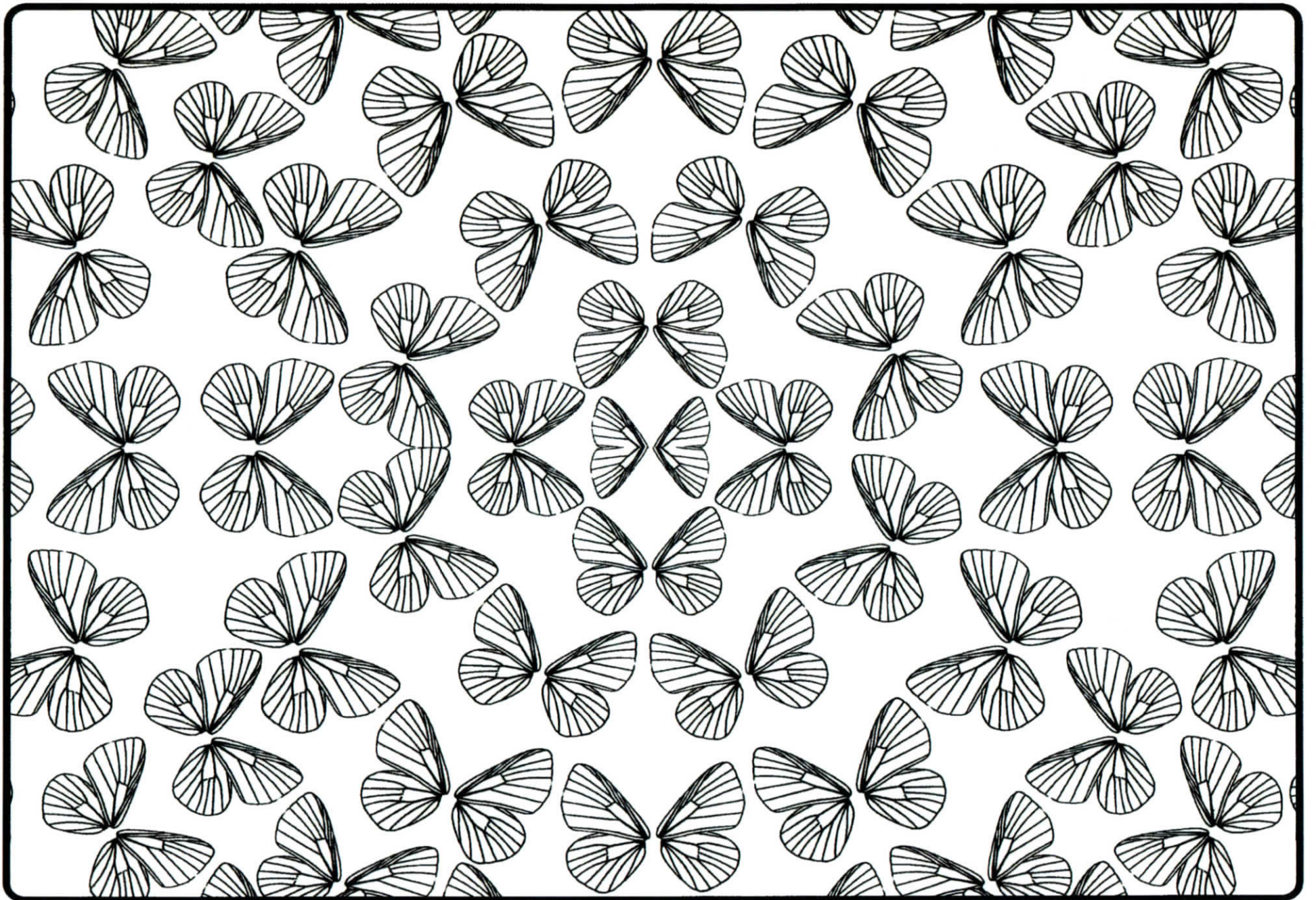

Origami House #1

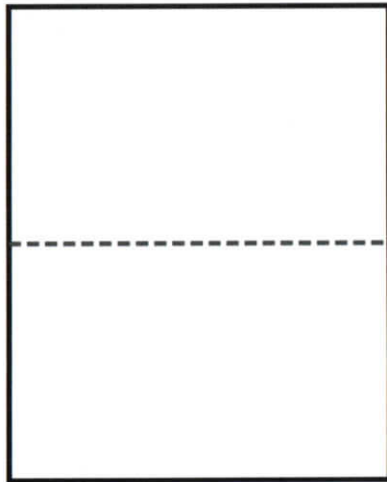

① Fold in half.

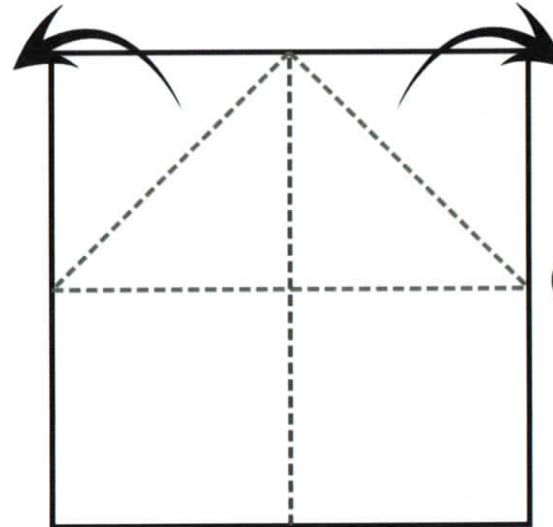

② Fold corners to meet along center crease.

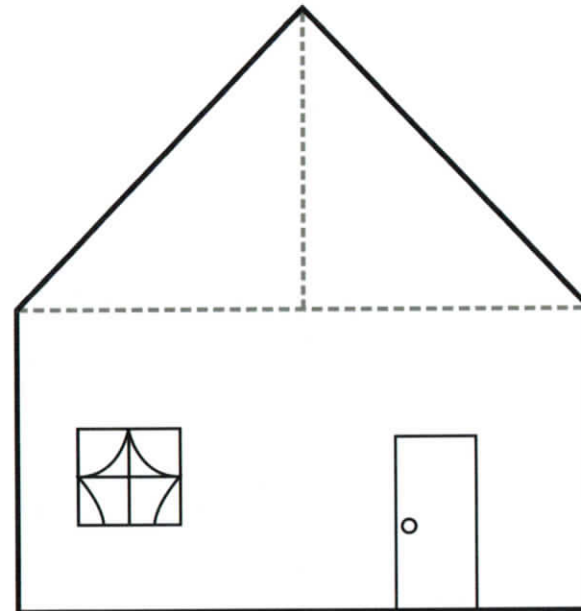
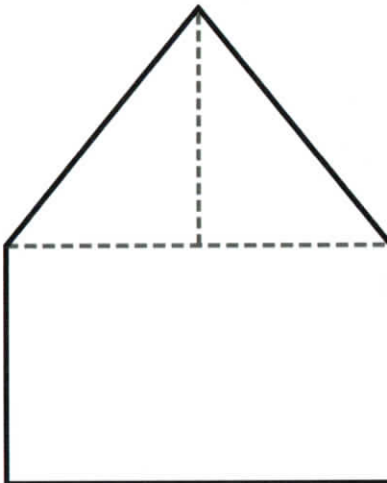

③ Decorate your house!



Origami House #1

(refer to page 1)

Cut this page out
to make your own!

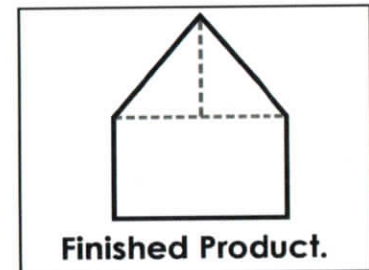

Cut along the
outside edges.



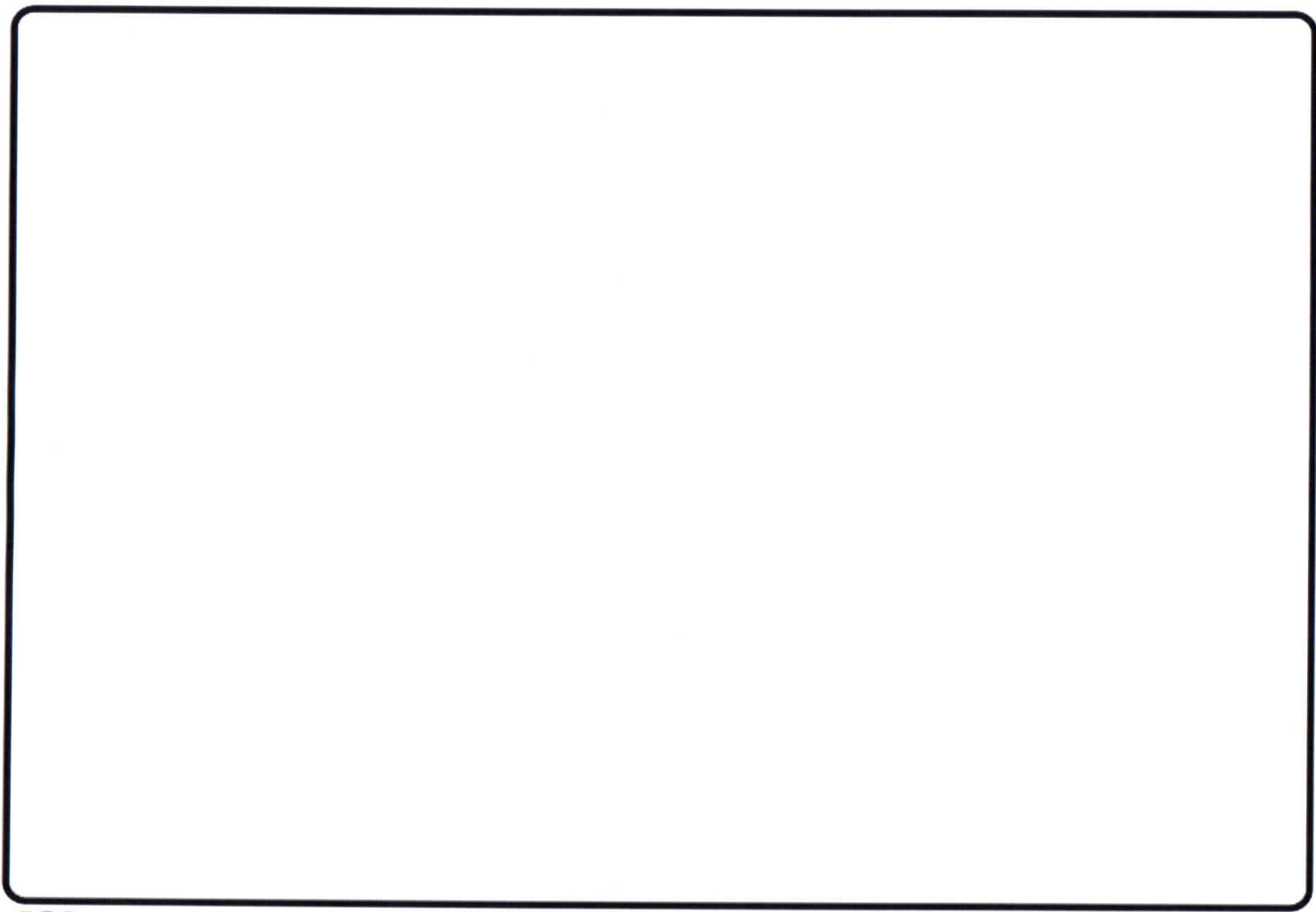

www.artsphere.org #artsphereinc @artsphereinc

Designed by

Design your own coloring sheet above and send with your bio to info@artsphere.org to be included on our web site and next book!

Origami House #2

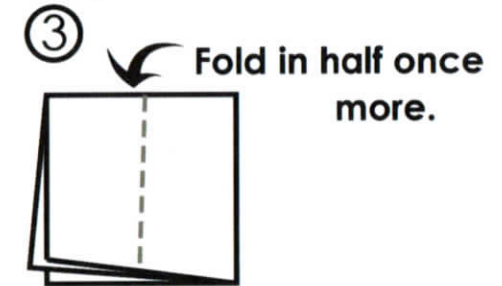
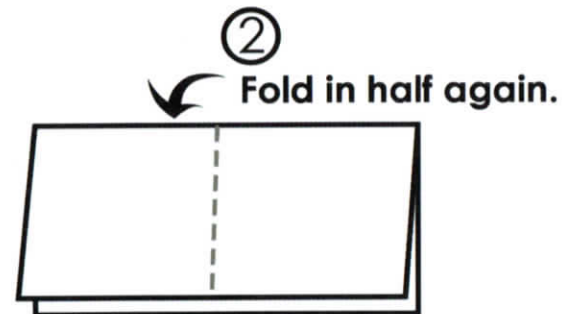
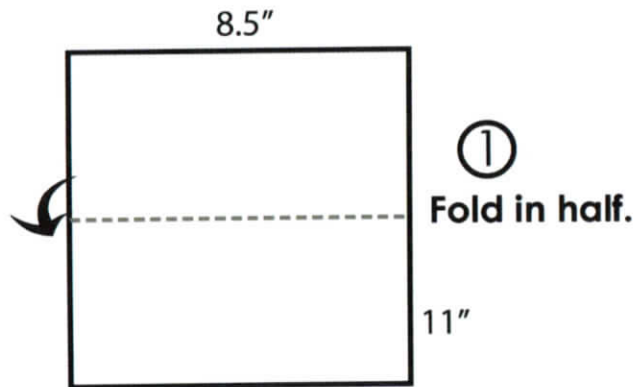

④ Unfold so you have 4 quarters created.

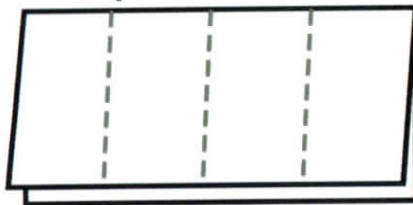

⑤ One at a time, fold each end up and press the corner down until it forms a triangle. This is the roof.

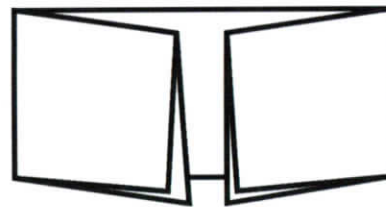

⑥ Do this to both ends.

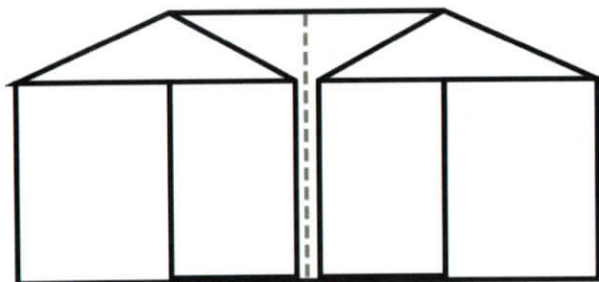
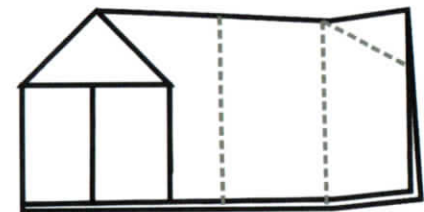

⑦ You should have a folded house!

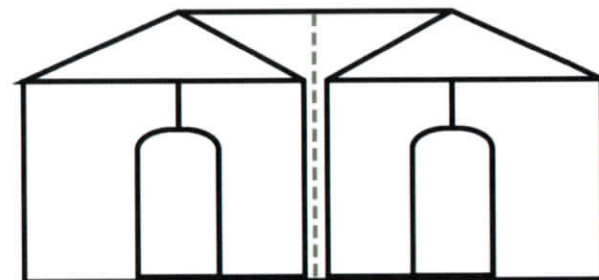

⑧ Now, add doors, window and architecture elements of your choice.



Cut this page out
to make your own!

Origami House #2



Origami Dog



Cut along the
outside edges.

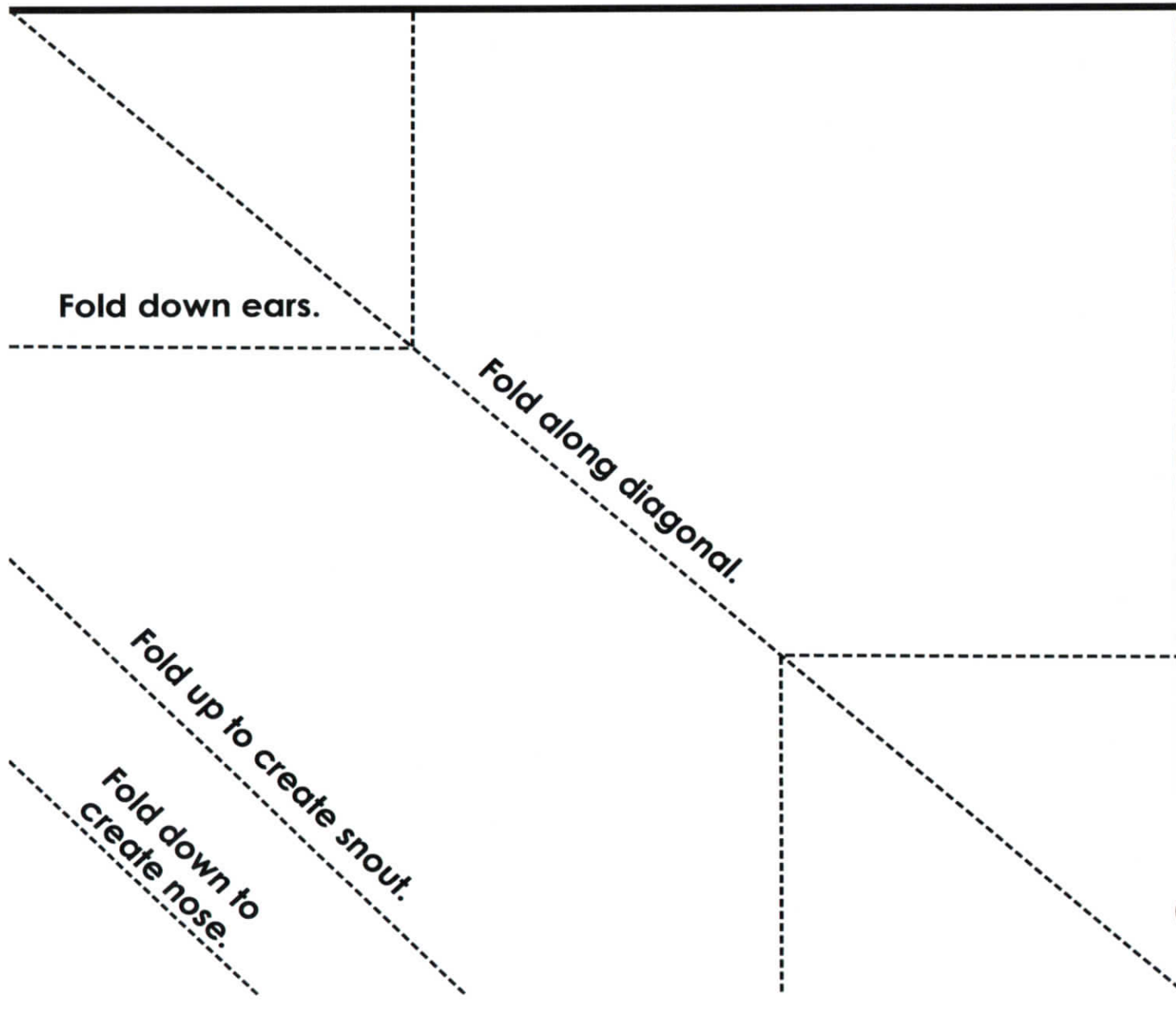

Fold down ears.

Fold along diagonal.

Fold up to create snout.

Fold down to create nose.



Origami Dog

① Fold in half.

② Fold up for tail.

Origami Pet body.



Cut along the outside edges.

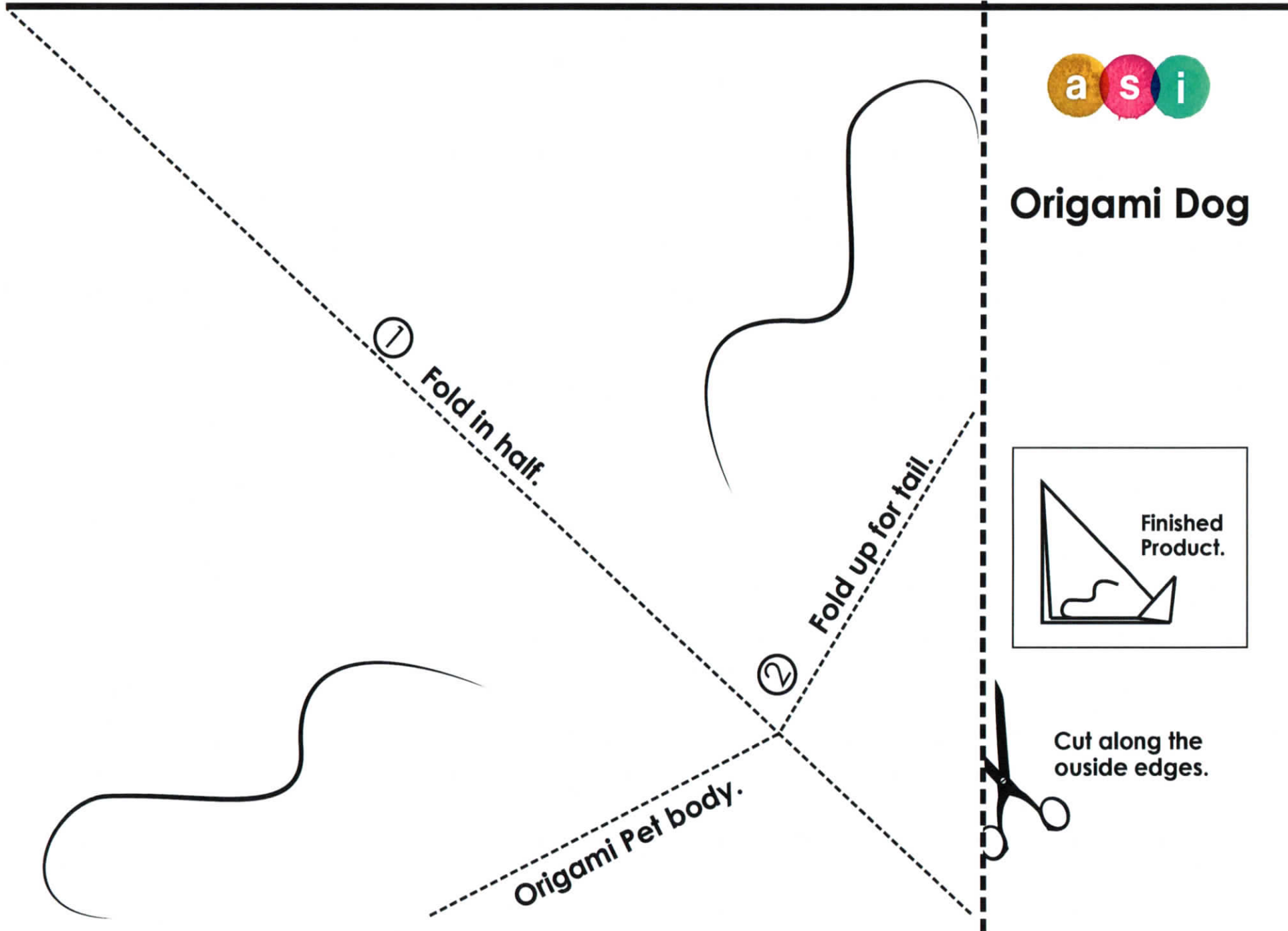



Origami Cat

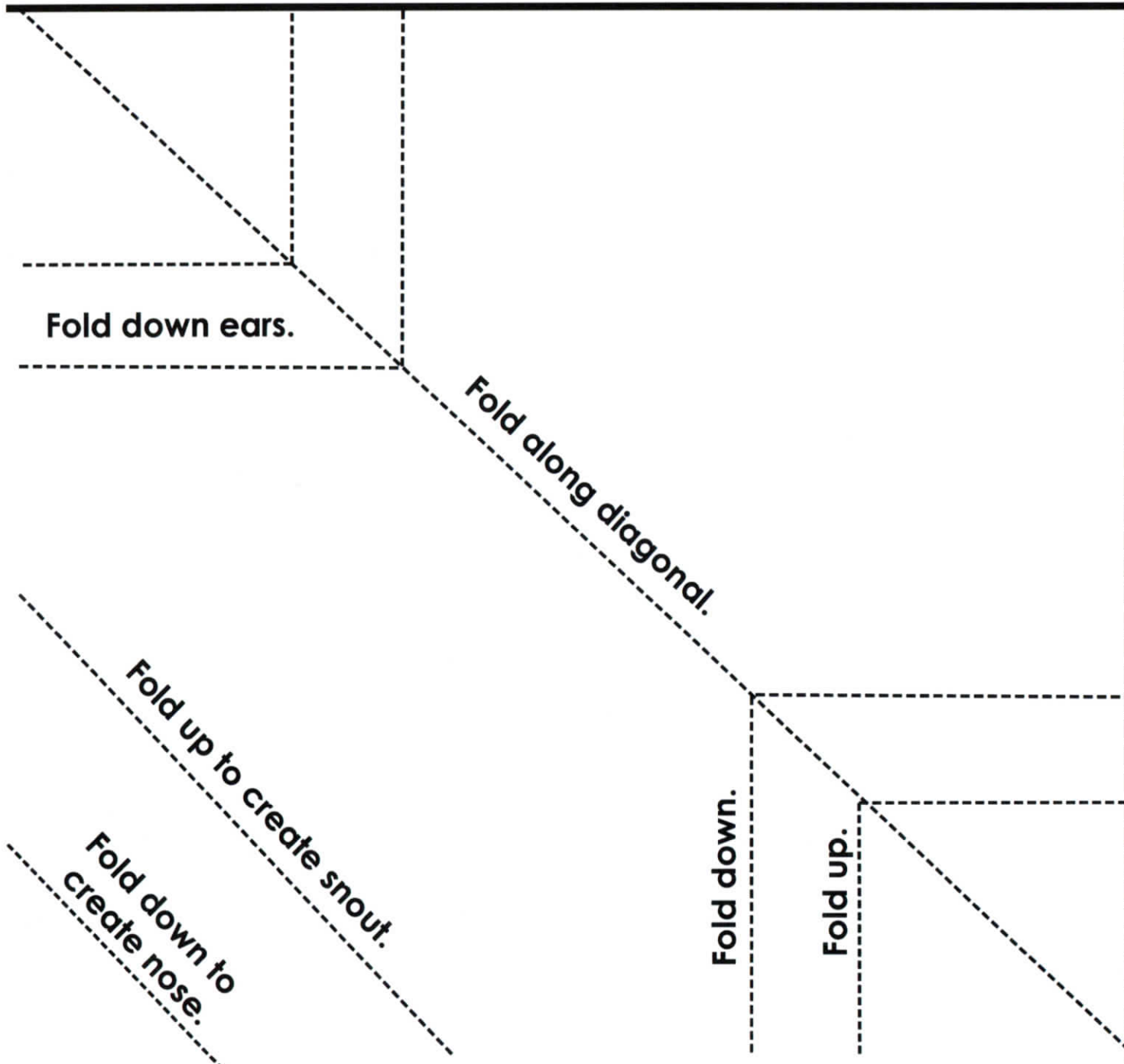
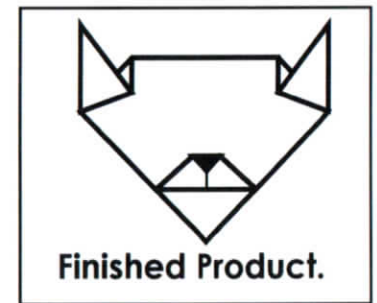

Cut along the outside edges.



Origami Cat

① Fold in half.

② Fold up for tail.

Origami Pet body.



Cut along the outside edges.

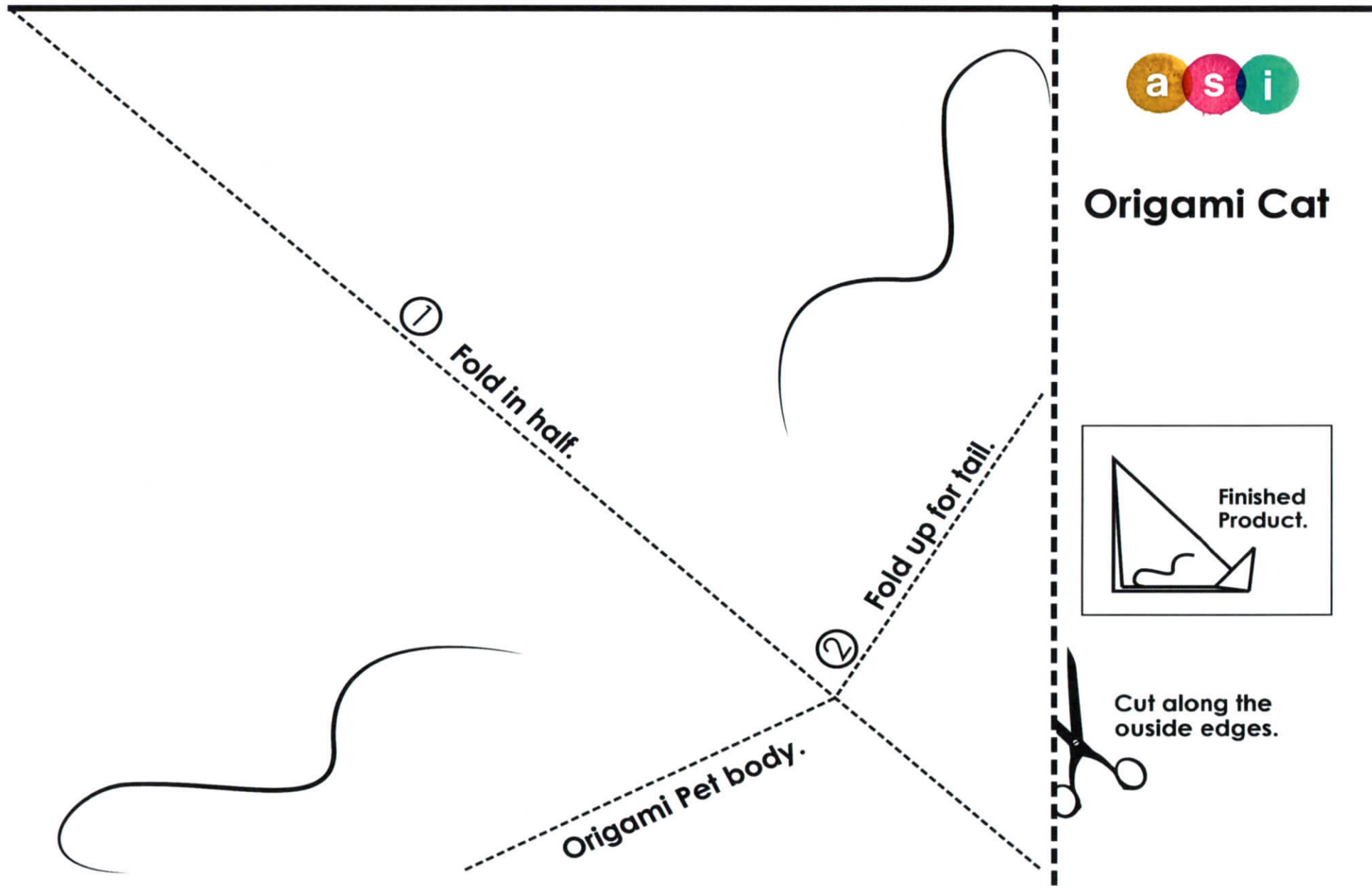

Origami Flower

Begin with two square sheets of paper.

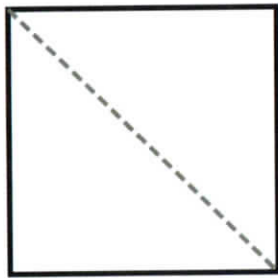

Fold in half along diagonal.

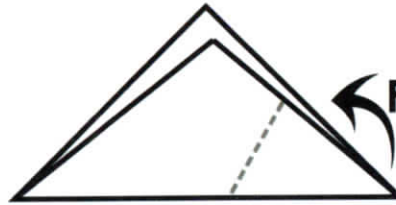

Fold up.

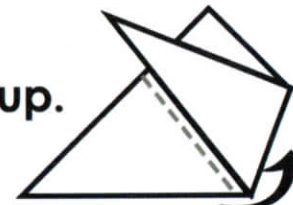

Fold up.

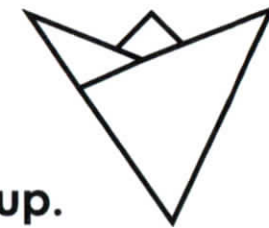

Flower Head.

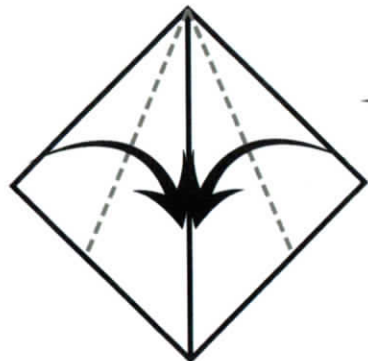

Fold edges to meet along diagonal center fold.

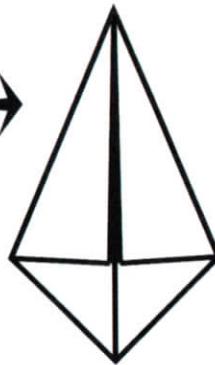

Fold up.

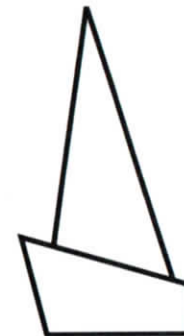

Flower Stem.

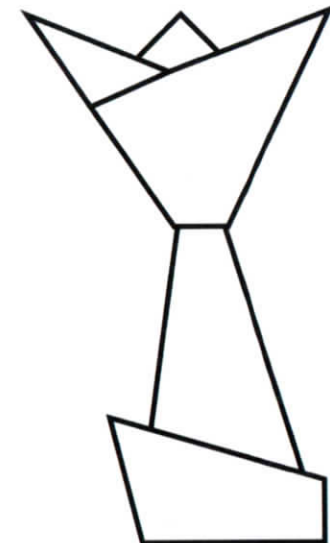

Finished Product !



Origami Flower Head

Directions:
Color your flower!
Cut along the outside
edges to make a square
sheet of paper, then
fold along the lines.
Refer to Origami Flower
instruction page.

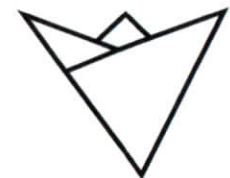

Finished Product.

**Cut along the
outside edges.**





Origami Flower Stem

Directions:
Color your stem!
Cut along the outside
edges to make a square
sheet of paper.
Fold on lines.
Refer to Origami
Flower instruction page.



Finished
Product.

Cut along the
outside edges.



Glue
here

Design your native Pennsylvania Fish!

Fold in half along the dotted line.
Cut along the outside edges.
Glue the outside edges together.
Hole punch near mouth and tie string.

Atlantic salmon

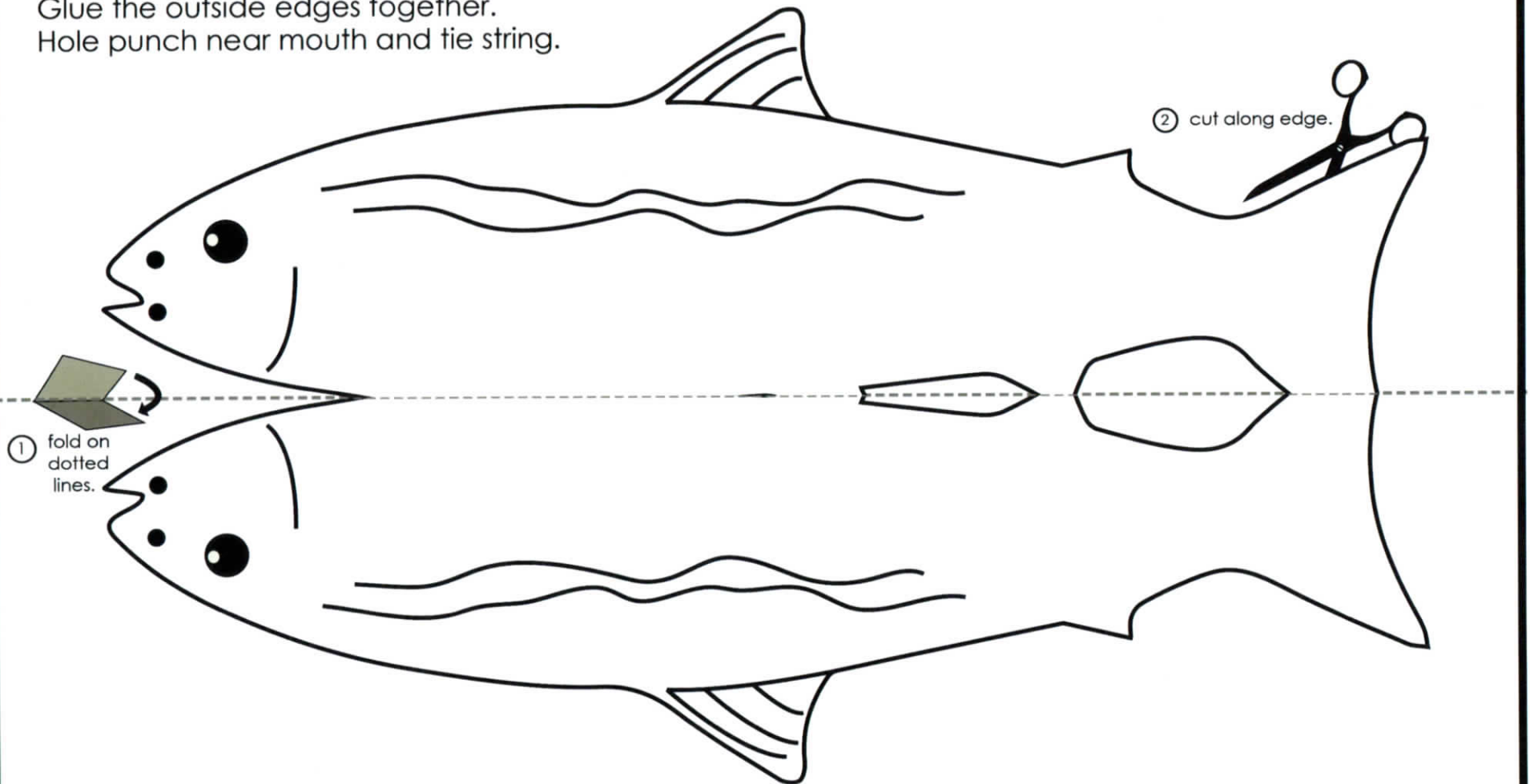

Design your native Pennsylvania Fish!

Fold in half along the dotted line.
Cut along the outside edges.
Glue the outside edges together.
Hole punch near mouth and tie string.

Banded Sunfish

① fold on dotted lines.

② cut along edge.

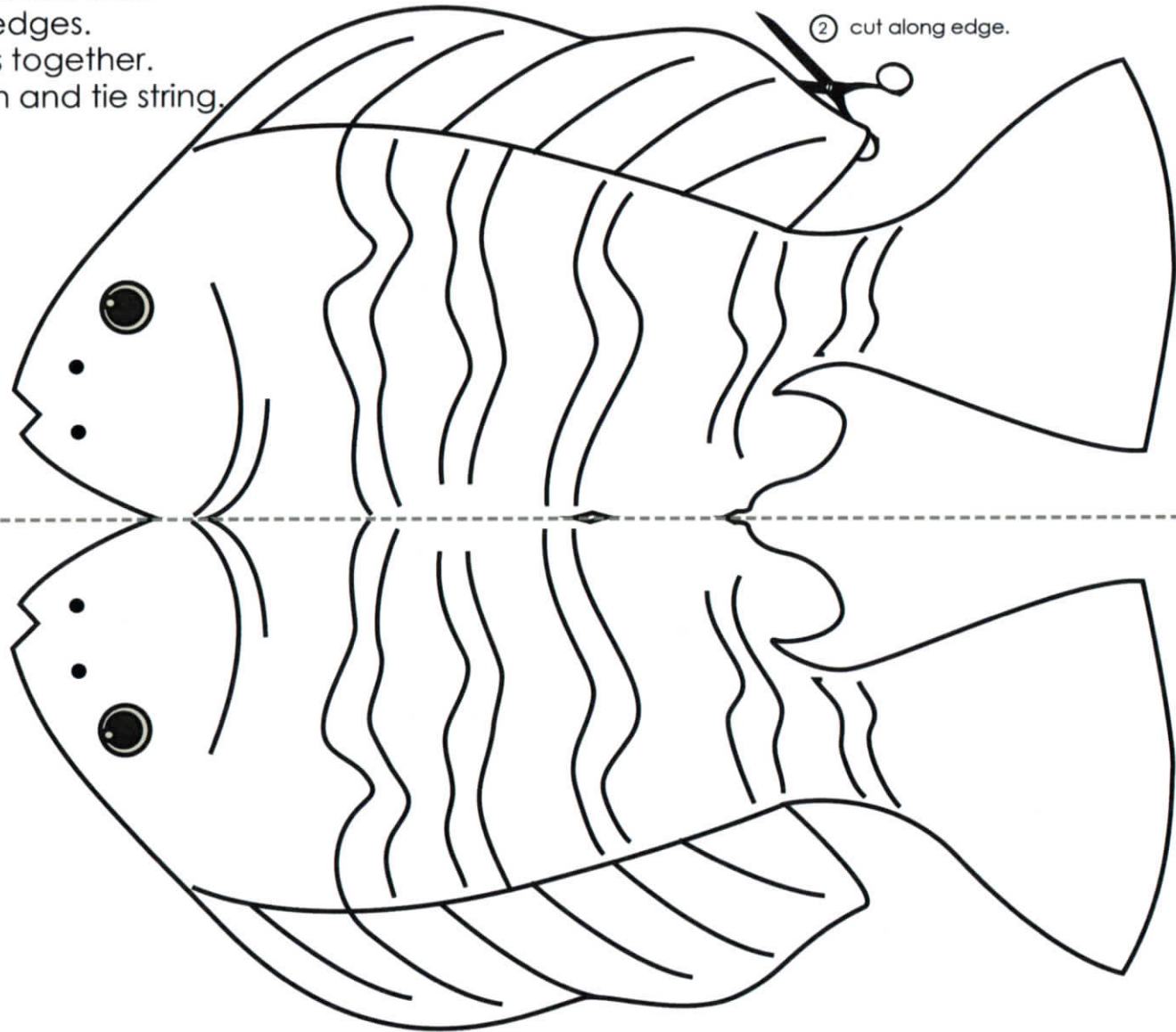

Design your native Pennsylvania Fish!

Fold in half along the dotted line.
Cut along the outside edges.
Glue the outside edges together.
Hole punch near mouth and tie string.

Redear Sunfish

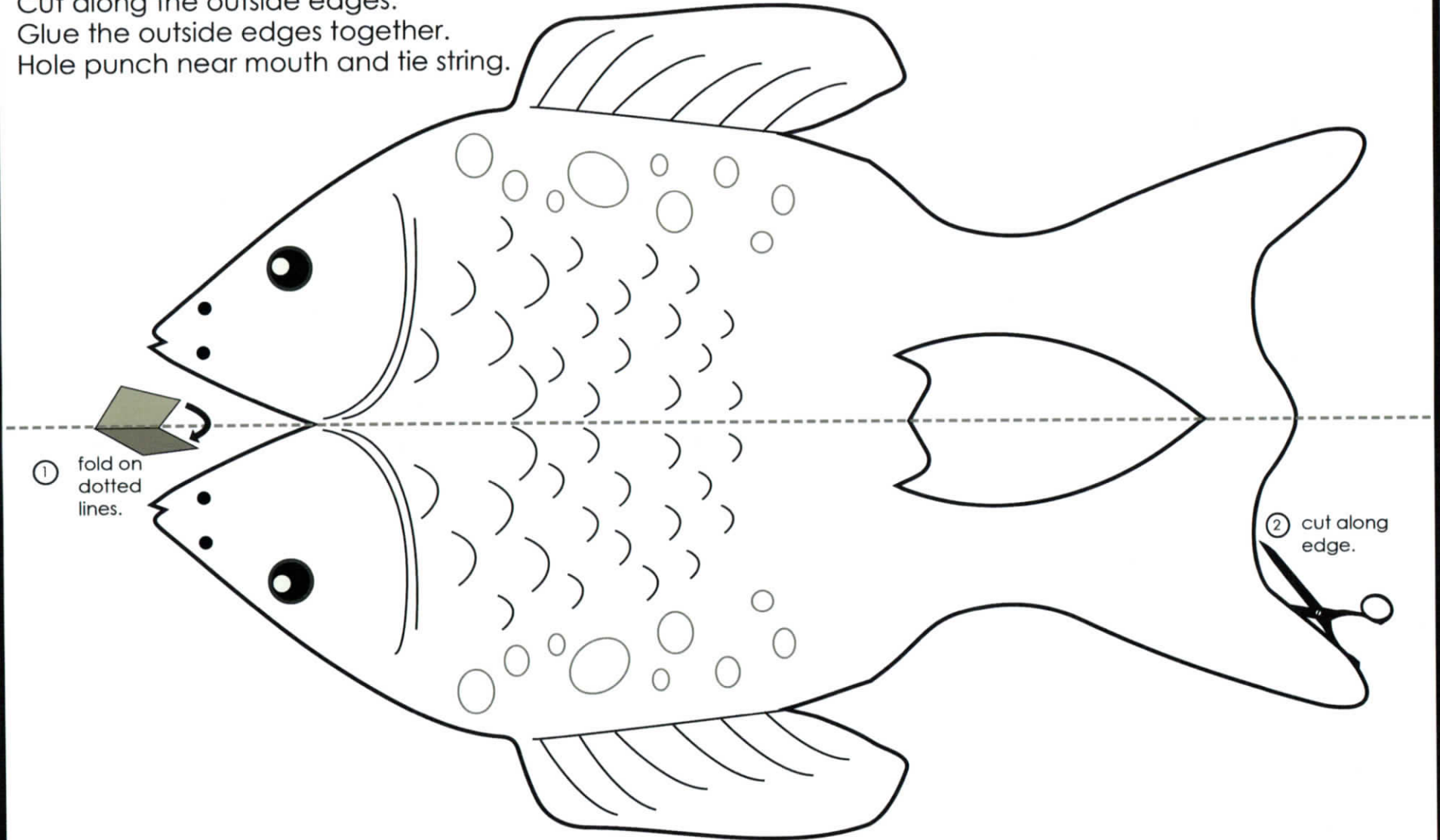

The Brook Trout

the state fish of Pennsylvania

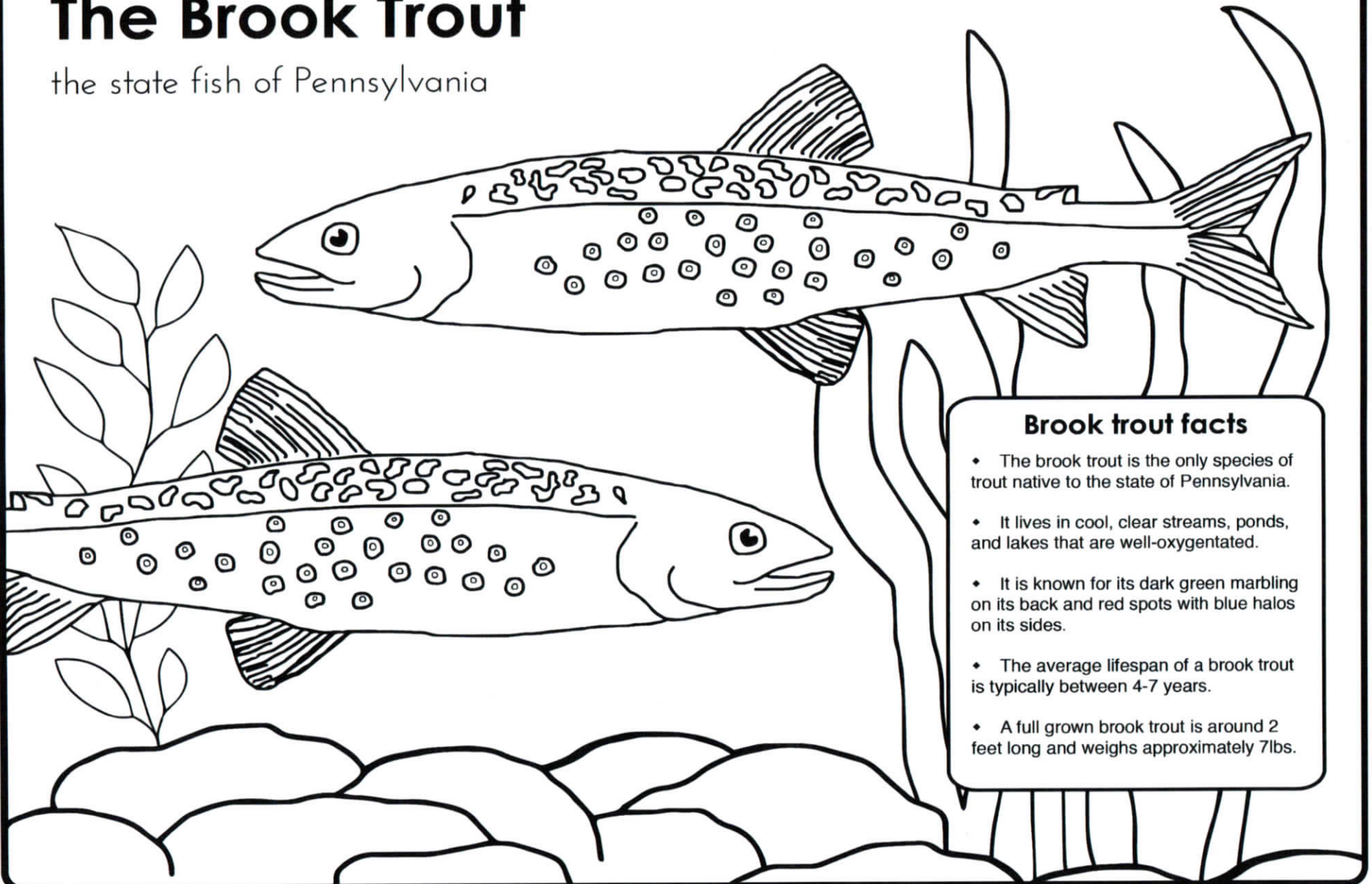

Brook trout facts

- The brook trout is the only species of trout native to the state of Pennsylvania.
- It lives in cool, clear streams, ponds, and lakes that are well-oxygenated.
- It is known for its dark green marbling on its back and red spots with blue halos on its sides.
- The average lifespan of a brook trout is typically between 4-7 years.
- A full grown brook trout is around 2 feet long and weighs approximately 7lbs.

What's in your jar ?



Create your own masterpiece!

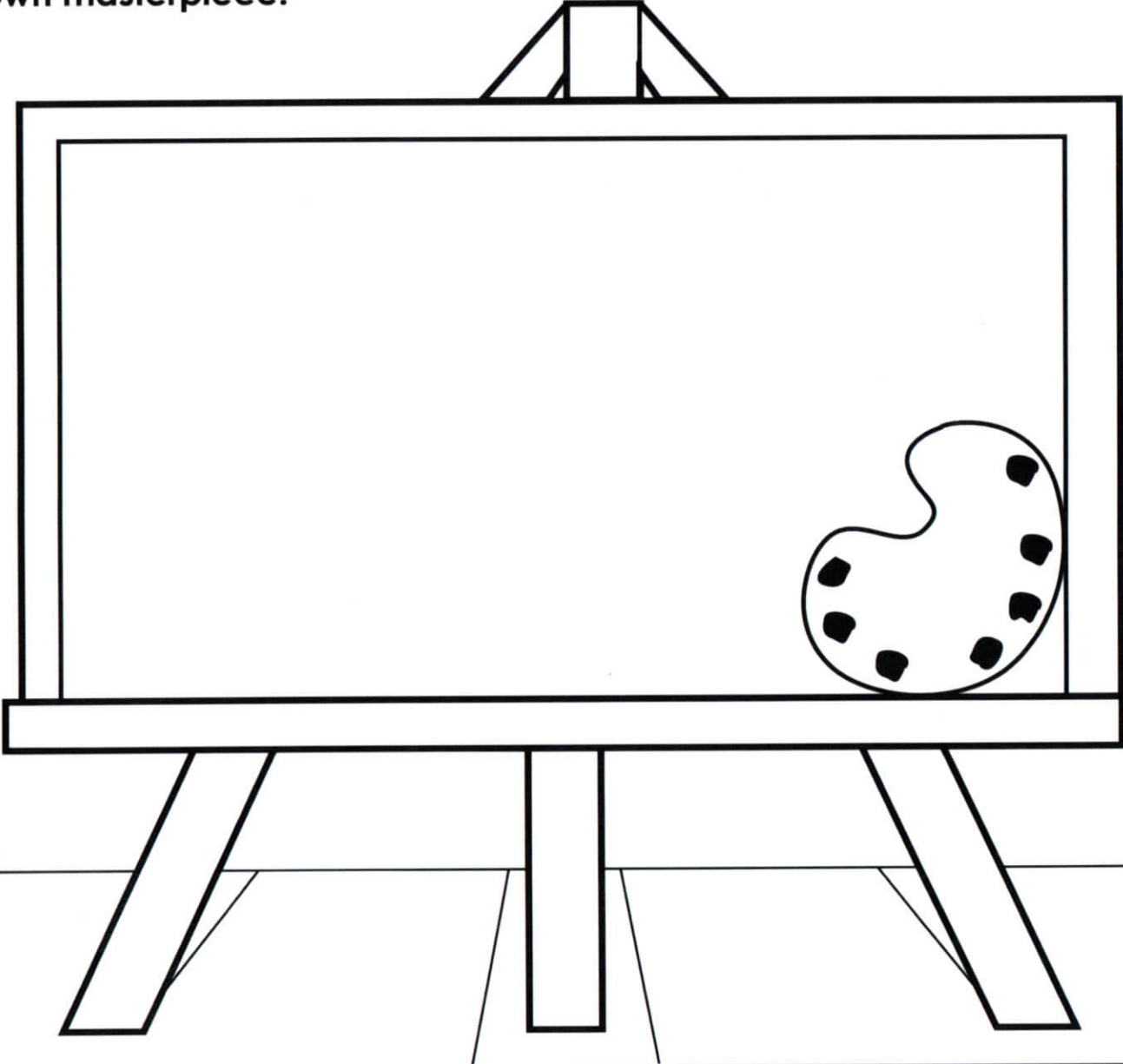

Origami Fan.

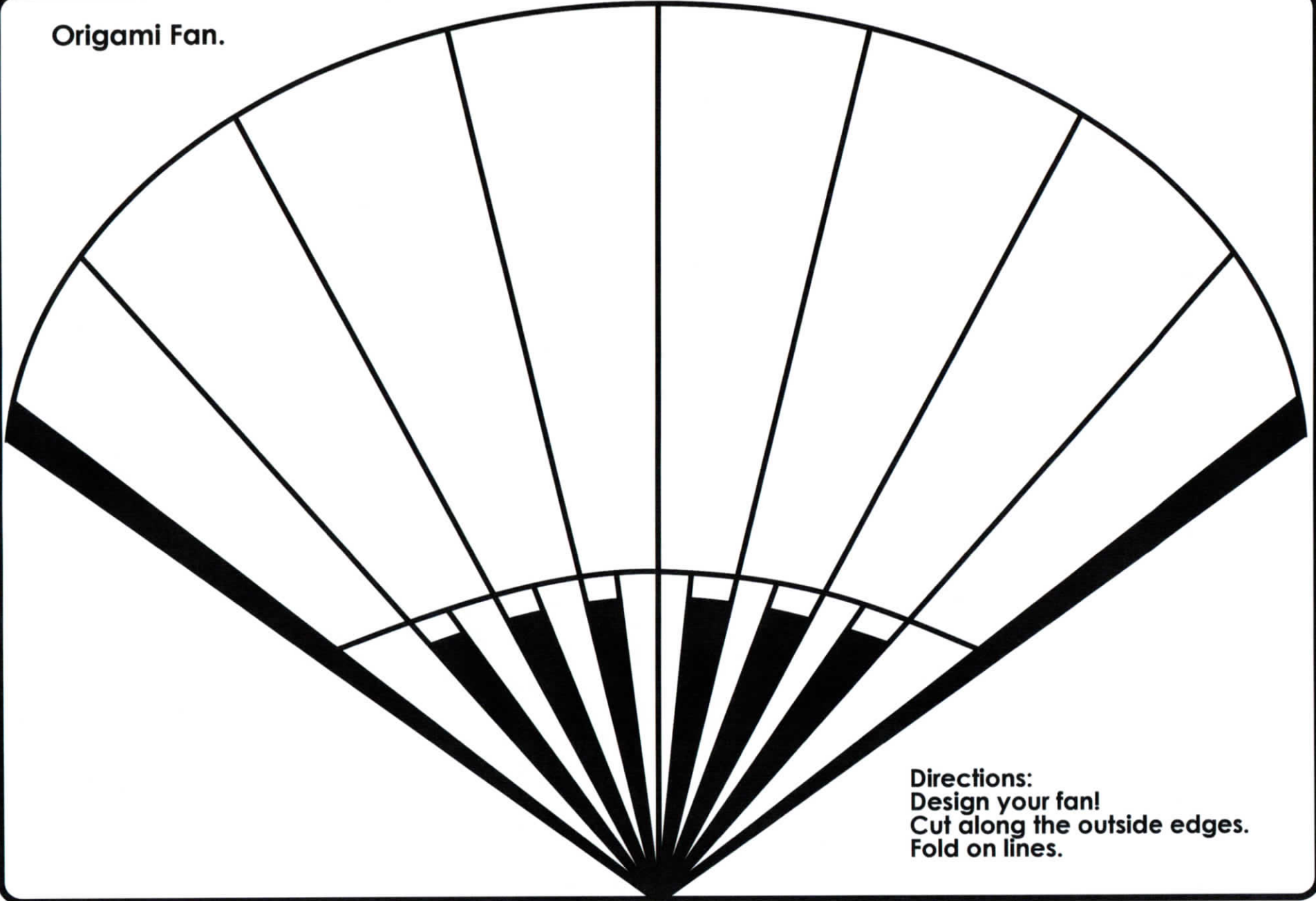

Directions:
Design your fan!
Cut along the outside edges.
Fold on lines.

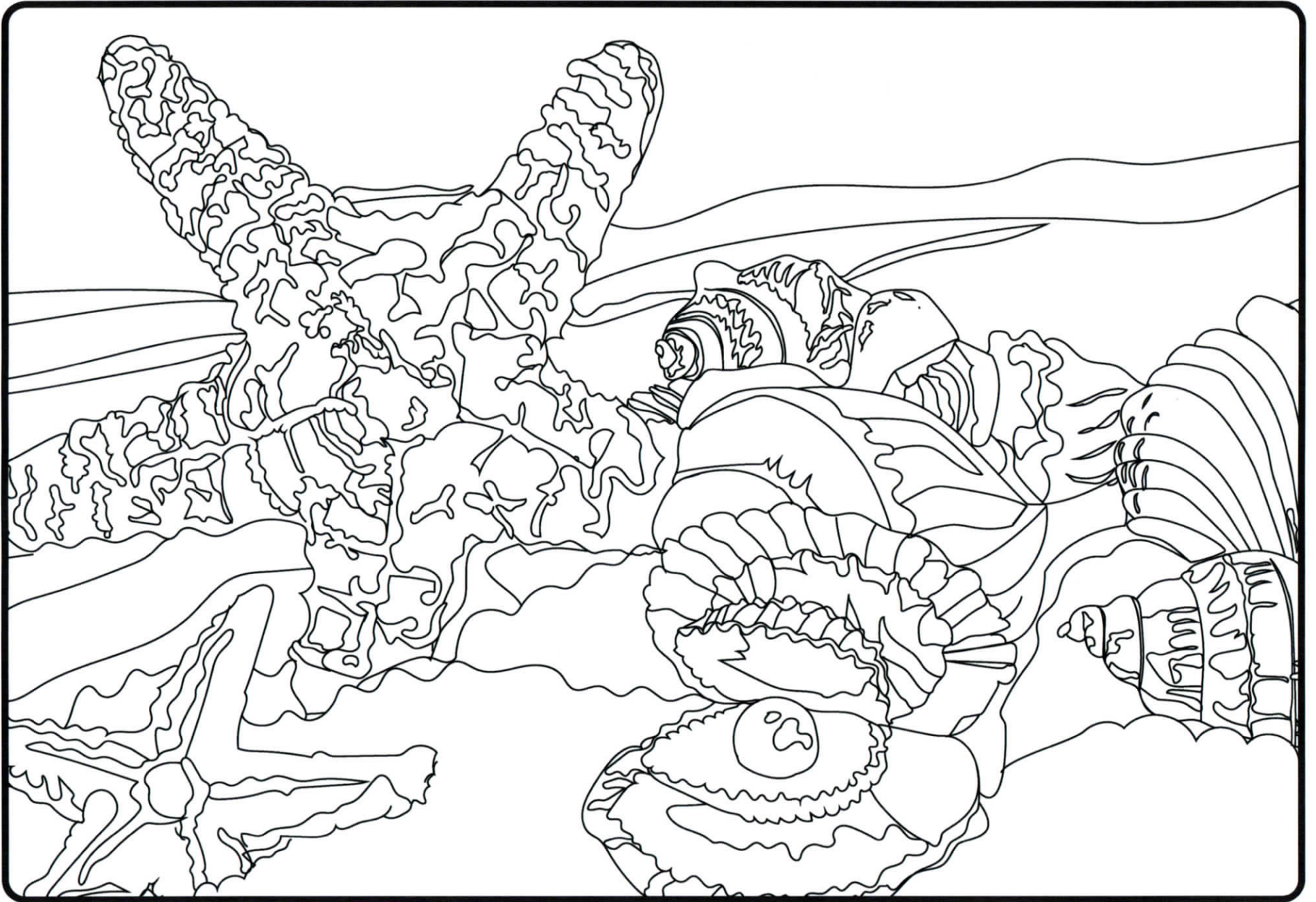



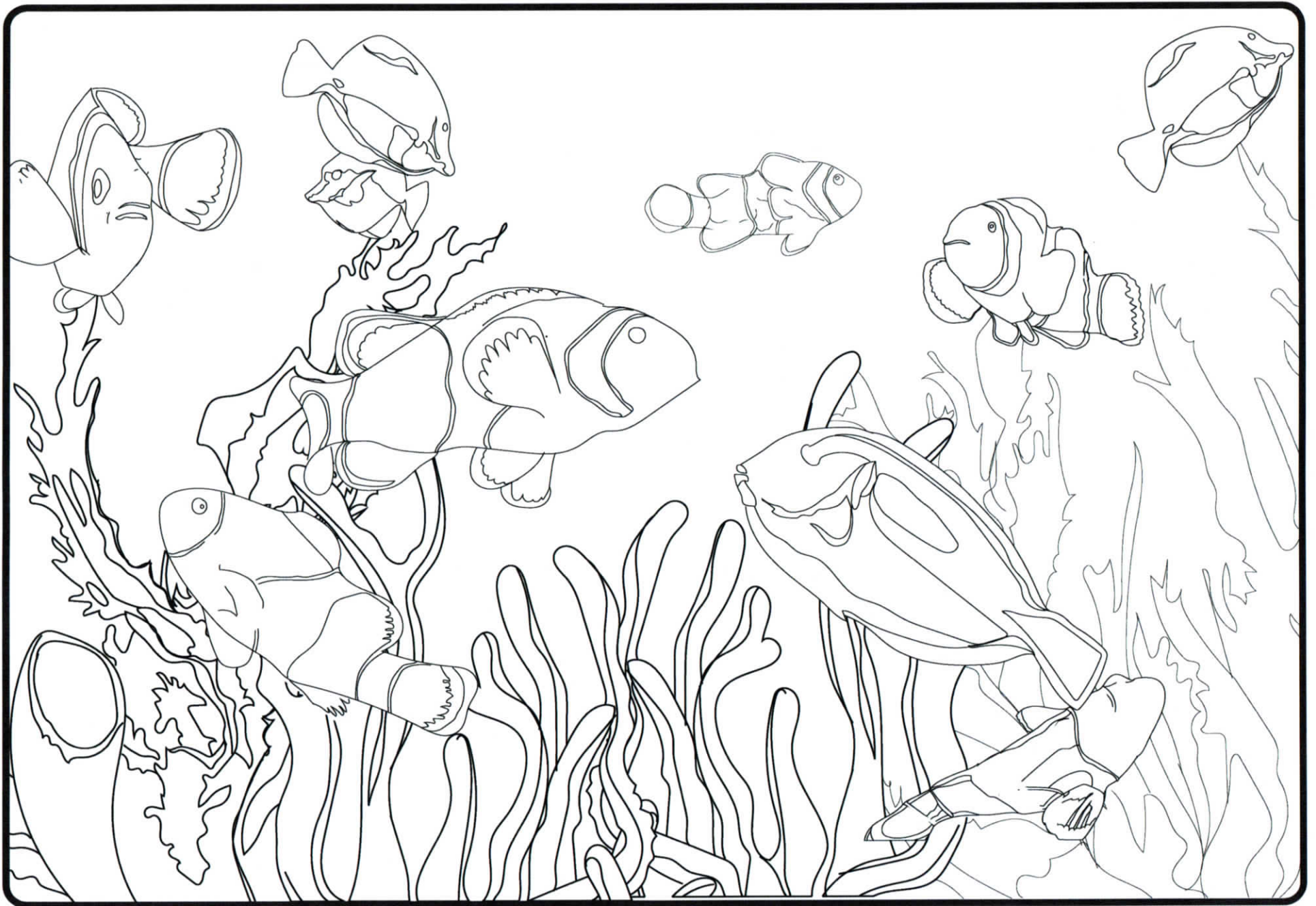





LAUGH OUT LOUD



SING OUT LOUD



READ OUT LOUD



Illustrate and write a story, then remake it into a riddle, a poem or a song.
Build your reading skills by reading out loud with family and friends!

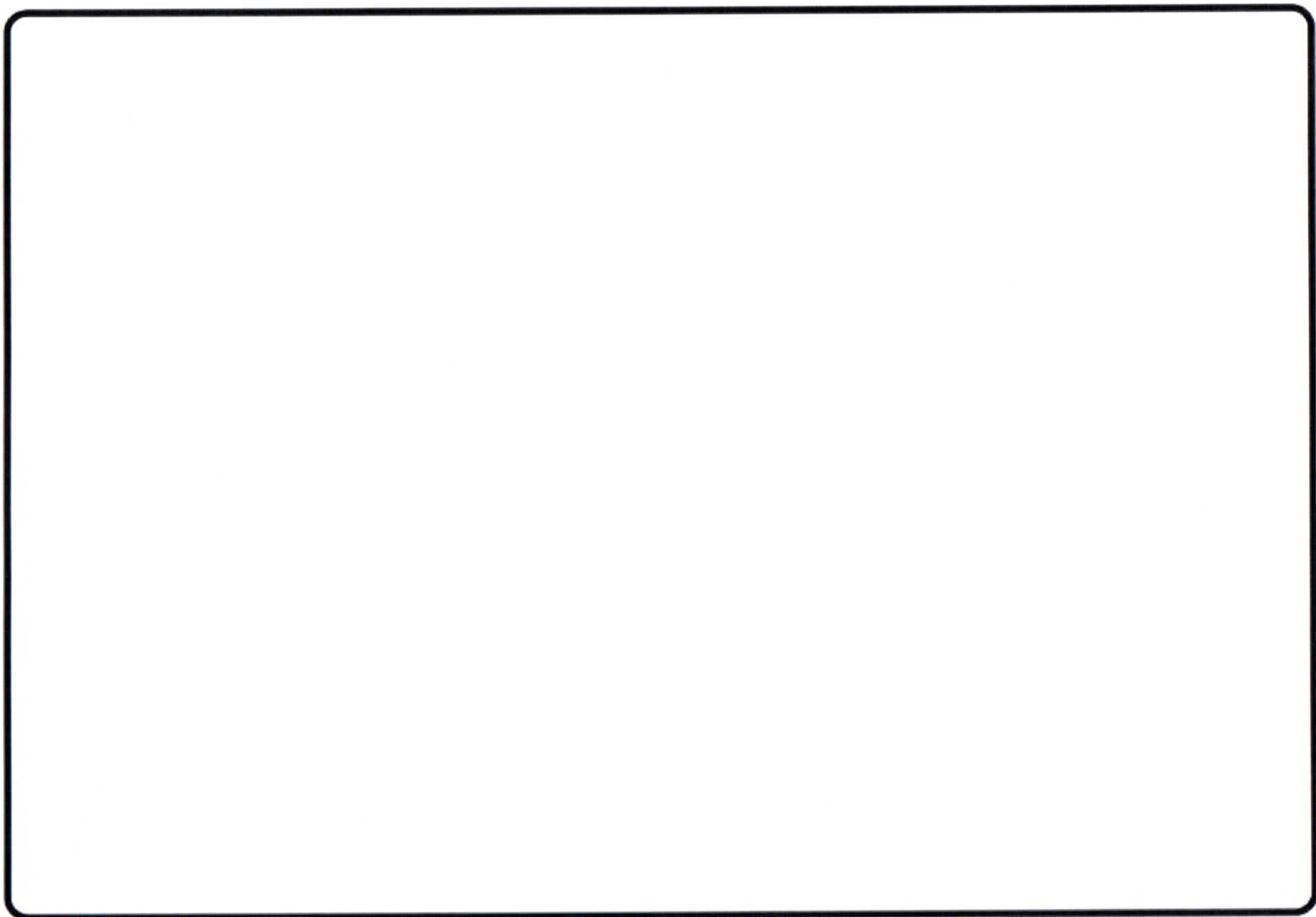



About Us

Art Sphere Inc. (ASI), founded in 1998, provides meaningful art programs for underserved populations in an effort to engage the creativity in communities, empower neighborhoods, explore the positives in peoples' lives, and heal the mind, body, and spirit through art.

Working with hundreds of volunteers every year and partnering with numerous civic and governmental organizations, our grassroots mural painting and park clean-up events help support inner-city neighborhoods. ASI's in-school and after-school workshops lay the framework for art to nourish the character and development of youth, open up a new world of social engagement and reinforce the school curriculum.

"You can't use up creativity. The more you use, the more you have." Maya Angelou

Thank You for planting the seed of education for future generations to learn and to express their creativity. This book would not have been possible without the participation of many talented and dedicated volunteers and supporters. We would like to thank the following artists whose designs are included in this book and for whose support we are most grateful: Katrina Stokes, Meredith Jensen, Ugonna Muoghalu, Tara Betts, Layveana Terrell, Katherine Katzin, and Kristin Groenveld.

Our thanks also go to Judy Yellin and Sarah Gregory for organizing contributions to this book, editing ASI teaching handouts and assembling them for us to share. A special thank you to our Board of Directors: Erica Bettwy, P.J. Hakim, Subrata Mukherjee, John Groenveld, Tiffany Mercer-Robbins and Cliff Price.

Please check our blog for more suggestions on creative art projects.

<http://www.artsphere.org/wp/category/lesson-plans/>
Instagram (<https://instagram.com/artsphereinc/>)

Share the art, make and creative ideas and let others know about our free online version of this book and our other free curricula:

#coloringthegardenofyourmind
#takeanartjourney
#creatinglegaciesthroughart
#loveartsphereinc

Art Sphere Inc. brings us together so we can make a better, safer, more hopeful world through the power of creativity.

©2016, Art Sphere Inc. Except where otherwise noted, this work is subject to a Creative Commons Attribution-NonCommercial Share Alike 4.0 International License. For details, see the Art Sphere Inc.

Copyright Statement at: <http://artsphere.org/about-us/copyright-and-disclaimer/>